

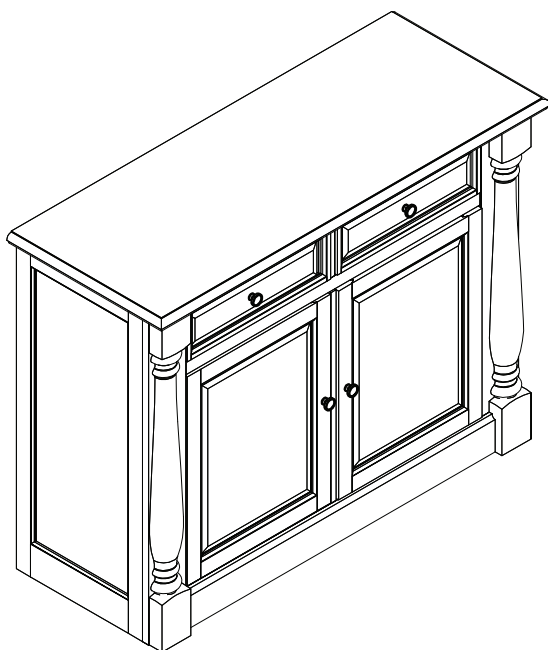

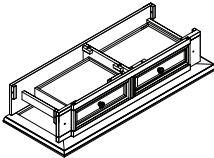

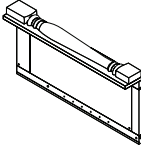

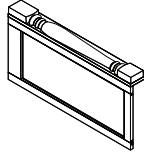

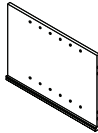
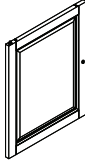
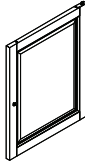
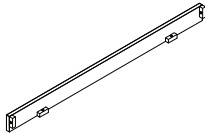
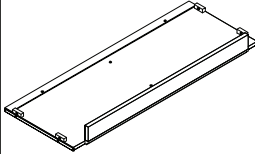
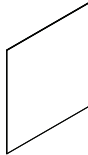
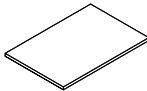





Buffet
CF4206

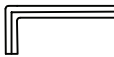

PART LIST

				
Top Panel 1 PC	Left Side Panel 1 PC	Right Side Panel 1 PC	Middle Panel 1 PC	Left Door 1 PC
				
Right Door 1 PC	Rail 1 PC	Bottom Panel 1 PC	Back Panel 2 PCS	Adjustable Shelf 4 PCS

HARDWARE LIST

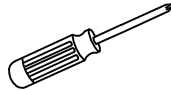
				
1-1/4"x ϕ 1/4"x D12 Short Bolt 15 PCS (Extra 1)	Spring Washer 20 PCS (Extra 1)	Flat Washer 20 PCS (Extra 1)	Allen Wrench 1 PC	5/8"x 1-1/4"L Wood Dowel 5 PCS (Extra 1)
				
Shelf Holder 17 PCS (Extra 1)	1/8"x 5/8"L Screw 9 PCS (Extra 1)	Knob 2 PCS	1"x ϕ 5/32"x D9 Round Head Bolt 3 PCS (Extra 1)	Door Magnet 4 PCS
		<p>ADDITIONAL TOOLS (Not Provided)</p> <p>Note: It is not recommended to use power tools during assembly.</p>  <p>Phillips Head Screwdriver</p>		
Safety Strap Kit 1 SET	2"x ϕ 1/4"x D12 Long Bolt 5 PCS (Extra 1)			

Step 1. Carefully lay top panel (part A) on a soft surface such as carpet as shown. Attach door magnets (part #10) to top panel (part A) using screws (part #7) and Phillips head screwdriver.

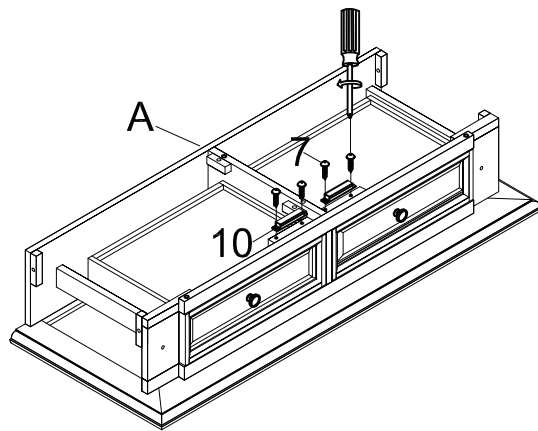

#7  X 4

#10  X 2

Step 2. Attach door magnets (part #10) to bottom panel (part H) using screws (part #7) and Phillips head screwdriver.

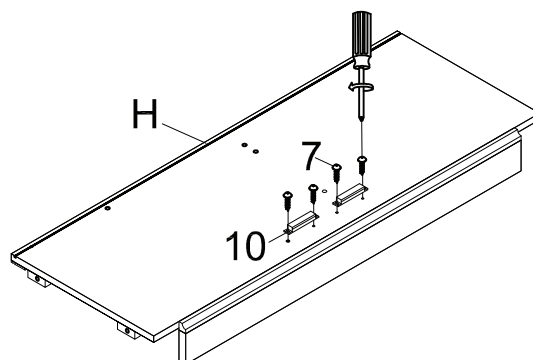



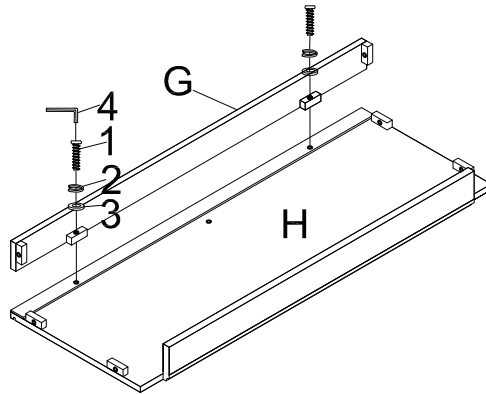

#7  X 4

#10  X 2





Step 3. Attach rail (part G) to bottom panel (part H) using short bolts (part #1), spring washers (part #2), flat washers (part #3) and allen wrench (part #4).

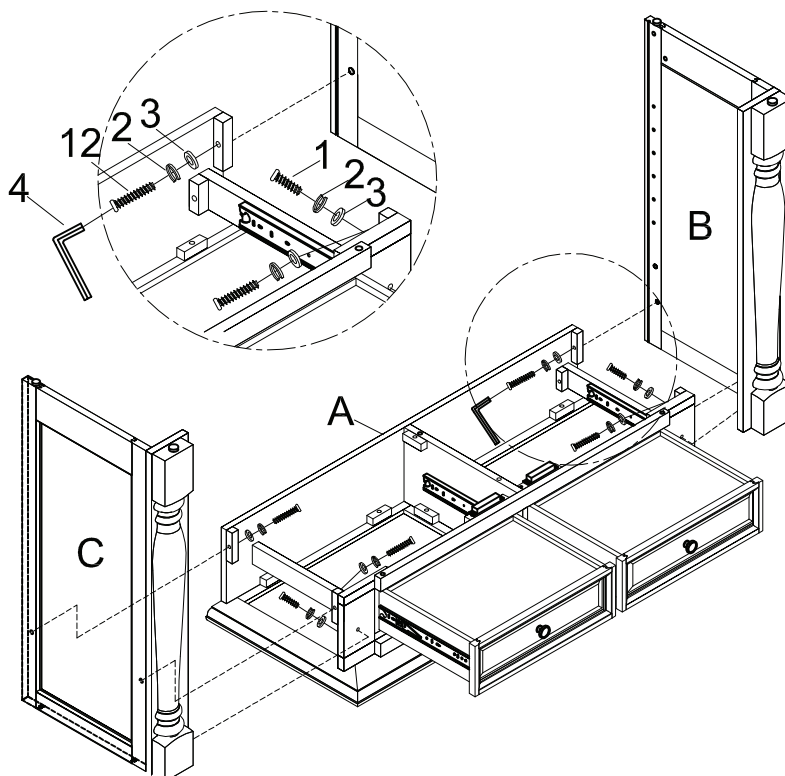

- #1  X 2
- #2  X 2
- #3  X 2
- #4  X 1

Step 4. Open drawers on top panel (part A) as shown. Attach left side panel (part B) and right side panel (part C) to top panel (part A) using short bolts (part #1), long bolts (part #12), spring washers (part #2), flat washers (part #3) and allen wrench (part #4).



- #1  X 2
- #2  X 6
- #3  X 6
- #4  X 1
- #12  X 4

Step 5. Attach middle panel (part D) to top panel (part A) using short bolts (part #1), spring washers (part #2), flat washers (part #3), wood dowels (part #5) and allen wrench (part #4).

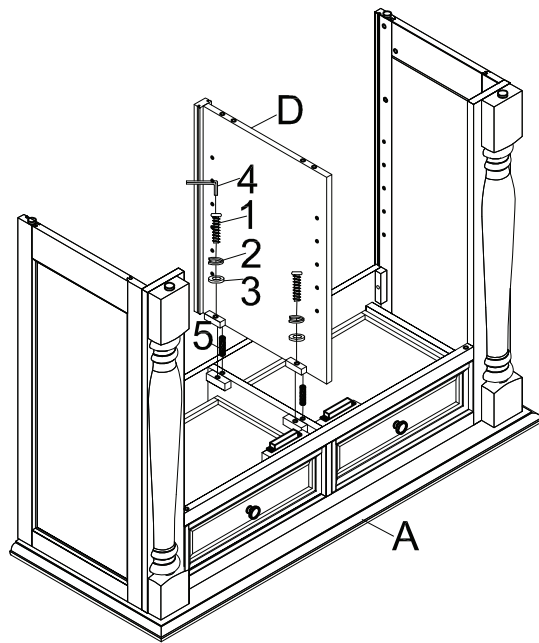

#1  X 2

#2  X 2

#3  X 2

#4  X 1

#5  X 2

Step 6. Slide back panels (part I) into grooves of left side panel (part B), right side panel (part C), and middle panel (part D) as shown below.

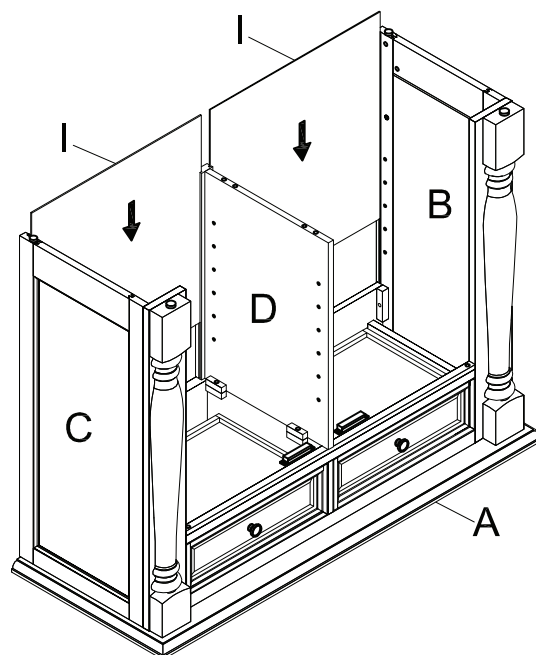

Step 7. Attach bottom panel (part H) and rail (part G) to left side panel (part B), right side panel (part C) and middle panel (part D) using short bolt (part #1), spring washers (part #2), flat washers (part #3), wood dowels (part #5) and allen wrench (part #4).

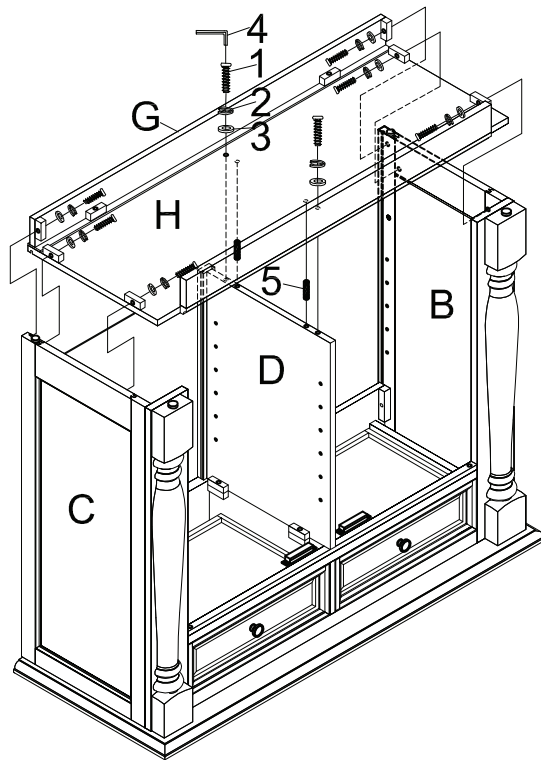

#1  X 8

#2  X 8

#3  X 8

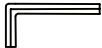
#4  X 1

#5  X 2

Step 8. Carefully turn the unit upright. Place shelf holders (part #6) into desired position and then slide adjustable shelves (part J) into place.

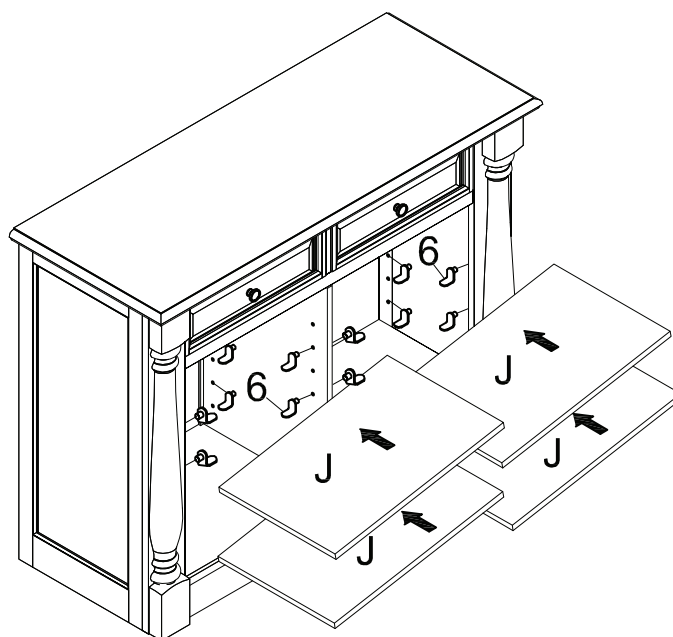





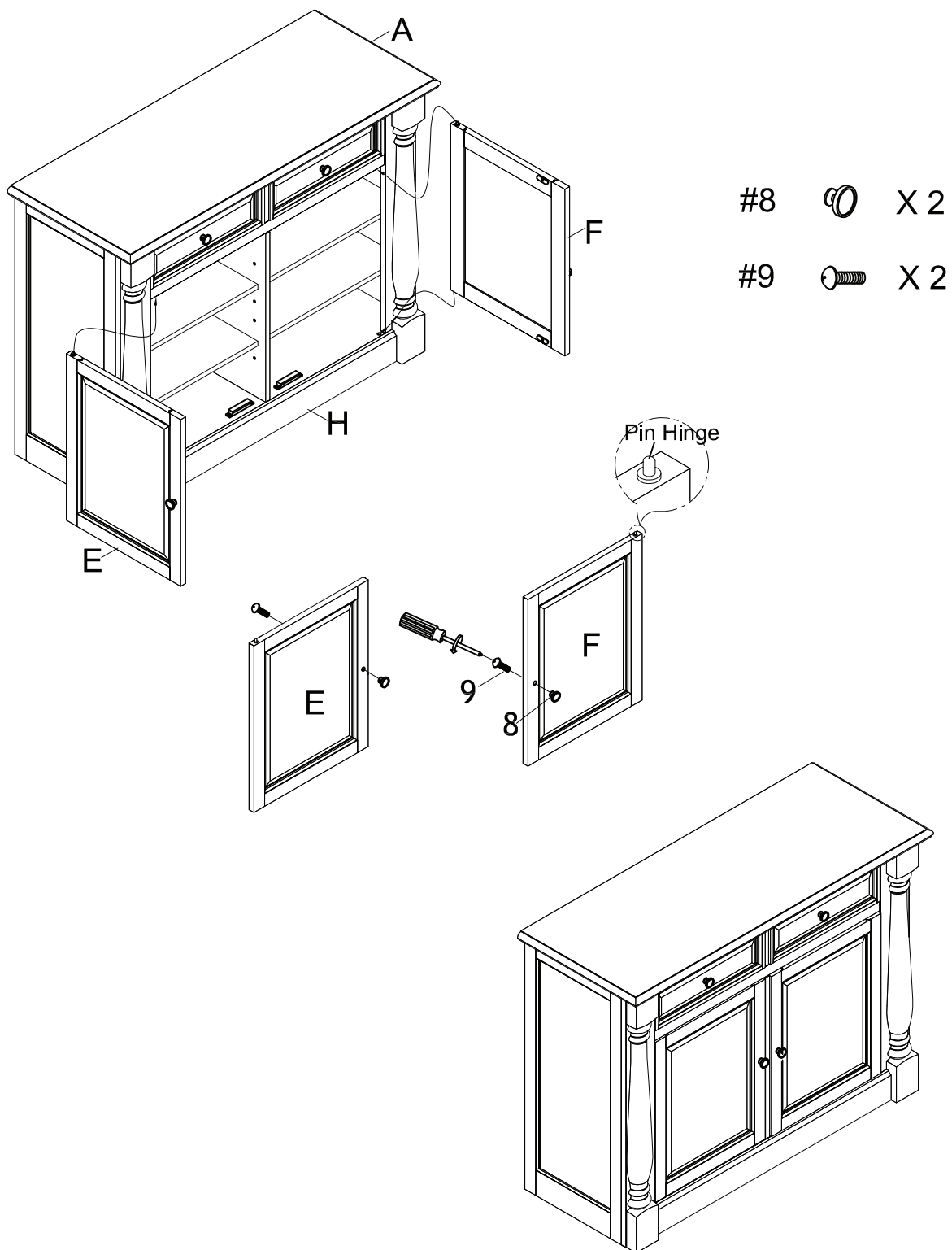

#6  X 16

Step 9. Attach knobs (part #8) to left and right doors (parts E & F) using round head bolts (part #9) and Phillips head screwdriver. Install left and right doors (parts E & F) by placing the bottom pin hinges (pre-installed in doors) in the pre-drilled holes of bottom panel (part H), and then depressing the top spring-loaded pin hinges so they can be placed in the pre-drilled holes of top panel (part A).
Note: Be sure top and bottom pin hinges are fully extended to secure doors in place.



Step 10.

11	A	B	C	D	E
					
Safety Strap Kit 1 SET	Wall Anchor 1 PC	Bracket 2 PCS	5/8"x ϕ 3xD8 Short Screw 1 PC	1-1/2"x ϕ 4xD8 Long Screw 1 PC	Safety Wall Strap 1 PC

SAFETY WALL STRAP INSTALLATION

Note: It is highly recommended to install this safety strap kit to prevent tipping, damage and/or injury.

1. Insert short screw (C) and safety wall strap (E) through bracket (B) and attach to top panel (part A) using phillips head screwdriver.
2. Drill a 11/32" hole where you want to secure the unit. The drilled hole will be at the same height as the hole in top panel (part A) where bracket (B) is attached. Tap wall anchor (A) into the hole.
3. Insert long screw (D) and safety wall strap (E) through bracket (B) into wall anchor (A) using phillips head screwdriver.

Note: This item is not intended for clothing storage use.

